



Macon Plastics, Inc.

P
R
I
C
E

L
I
S
T

Gasketed Pressure

C-900 (Cast Iron O.D.)
DR 25 & DR 18

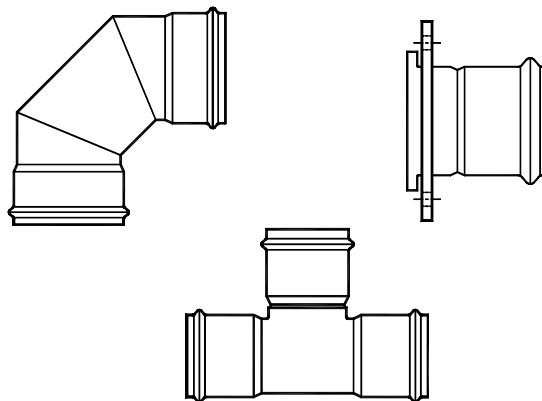

Effective Date: 03/03/08
Catalog Number: 207CPG
Supercedes: 206CPG

Not sure if you have a current catalog?
Check www.maconplastics.com
to view our current catalogs online.

Multiplier

Table of Contents

Adapter	1
Adapter Flange	1
Coupling, Repair	1
Coupling, Stop.....	1
Elbows.....	2
Reducer Bushing	1
Reducer Coupling.....	1
Spigot Plug	1
Spigot Plug, Tapped	1
Tee.....	3
Terms.....	4

Short Form Specification

All fittings for 4” through 12” C900 pipe shall be one-piece injection molded or fabricated from a PVC compound meeting ASTM D1784. Fittings shall conform to the requirements of DR 18 or DR 25. Solvent weld or gasketed fittings are option of the user. All fabricated fittings shall meet the requirements of ANSI/AWWA Standard C900-97. Solvent weld bells shall be compatible with C900 pipe. Gasket bells shall conform to ASTM D3139 with gaskets conforming to F477. Gaskets shall be locked-in style. All fabricated pressure fittings are made from segments of C900 pipe bonded together and over-wrapped with fiber-glass-reinforced polyester.

Adapter

C-900 Spigot X IPS Gasket

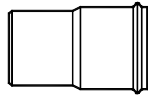

Size	DR 25			DR 18		
	Part Number	List Price	UPC 695783	Part Number	List Price	UPC 695783
4	50396	63.62	503963	47996	69.99	479961
6	50397	115.13	503970	47997	126.63	479978
8	50398	253.24	503987	47998	278.55	479985
10	50399	375.21	503994	47999	412.72	479992
12	50400	478.00	504007	47800	525.80	478001

Reducer Coupling

Gasket x Gasket

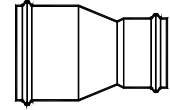

Size	DR 25			DR 18		
	Part Number	List Price	UPC 695783	Part Number	List Price	UPC 695783
6x4	51046	186.16	510466	48546	186.16	485467
8x4	51049	208.16	510497	48549	219.14	485498
8x6	51050	237.91	510503	48550	250.50	485504
10x6	51054	280.34	510541	48554	295.18	485542
10x8	51055	310.07	510558	48555	326.50	485559
12x8	51060	378.02	510602	48560	398.06	485603
12x10	51061	416.25	510619	48561	438.33	485610

Adapter Flange

Gasket X Flange

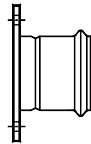

Size	DR 25			DR 18		
	Part Number	List Price	UPC 695783	Part Number	List Price	UPC 695783
4	50982	196.63	509828	48482	206.97	484828
6	50983	218.01	509835	48483	229.48	484835
8	50984	245.01	509842	48484	257.91	484842
10	50985	489.99	509859	48485	515.78	484859
12	50986	567.23	509866	48486	597.02	484866

Flanges rated at 150 PSI max

Reducer Bushing

Spigot x Gasket

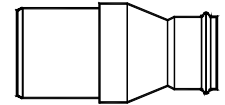

Size	DR 25			DR 18		
	Part Number	List Price	UPC 695783	Part Number	List Price	UPC 695783
6x4	51136	133.50	511364	48636	133.50	486365
8x4	51139	177.73	511395	48639	187.19	486396
8x6	51140	226.92	511401	48640	226.92	486402
10x6	51144	225.11	511449	48644	237.07	486440
10x8	51145	250.61	511456	48645	263.91	486457
12x8	51150	316.46	511500	48650	333.19	486501
12x10	51151	344.03	511517	48651	362.26	486518

Coupling, Repair

Gasket x Gasket

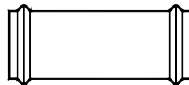

Size	DR 25			DR 18		
	Part Number	List Price	UPC 695783	Part Number	List Price	UPC 695783
4	50724	50.06	507244	48224	50.06	482244
6	50725	76.79	507251	48225	76.79	482251
8	50726	184.93	507268	48226	184.93	482268
10	50727	259.51	507275	48227	259.51	482275
12	50728	379.09	507282	48228	379.09	482282

Spigot Plug

Spigot x Cap



Size	DR 25			DR 18		
	Part Number	List Price	UPC 695783	Part Number	List Price	UPC 695783
4	51030	43.42	510305	48530	43.42	485306
6	51031	78.25	510312	48531	78.25	485313
8	51032	132.95	510329	48532	132.95	485320
10	51033	375.12	510336	48533	375.12	485337
12	51034	473.65	510343	48534	473.65	485344

Coupling, Stop

Gasket x Gasket

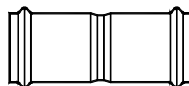

Size	DR 25			DR 18		
	Part Number	List Price	UPC 695783	Part Number	List Price	UPC 695783
4	50712	43.55	507121	48212	43.55	482121
6	50713	66.76	507138	48213	66.76	482138
8	50714	159.64	507145	48214	159.64	482145
10	50715	278.67	507152	48215	278.67	482152
12	50716	384.10	507169	48216	384.10	482169

Spigot Plug, Tapped



Size	DR 25			DR 18		
	Part Number	List Price	UPC 695783	Part Number	List Price	UPC 695783
4	50994	71.59	509941	48494	71.59	484941
6	50995	106.41	509958	48495	106.41	484958
8	50996	161.12	509965	48496	161.12	484965
10	50997	505.29	509972	48497	505.29	484972
12	50998	558.57	509989	48498	558.57	484989

Please specify tap size when ordering.

DR 14 fittings available on request. Contact factory for pricing.

11 1/4° EII
Gasket x Gasket



11 1/4° EII
Spigot x Gasket



Size	DR 25			DR 18		
	Part Number	List Price	UPC 695783	Part Number	List Price	UPC 695783
4	50838	80.81	508388	48338	84.03	483388
6	50839	140.20	508395	48339	140.20	483395
8	50840	266.98	508401	48340	266.98	483401
10	50841	399.27	508418	48341	420.43	483418
12	50842	520.32	508425	48342	547.92	483425

Size	DR 25			DR 18		
	Part Number	List Price	UPC 695783	Part Number	List Price	UPC 695783
4	50910	P.O.A.	509101	48410	P.O.A.	484101
6	50911	212.22	509118	48411	212.22	484118
8	50912	256.06	509125	48412	256.06	484125
10	50913	390.77	509132	48413	411.48	484132
12	50914	494.83	509149	48414	521.07	484149

22 1/2° EII
Gasket x Gasket

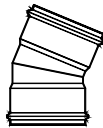

22 1/2° EII
Spigot x Gasket



Size	DR 25			DR 18		
	Part Number	List Price	UPC 695783	Part Number	List Price	UPC 695783
4	50850	80.81	508500	48350	84.03	483500
6	50851	140.20	508517	48351	140.20	483517
8	50852	266.98	508524	48352	266.98	483524
10	50853	399.27	508531	48353	420.43	483531
12	50854	520.32	508548	48354	547.92	483548

Size	DR 25			DR 18		
	Part Number	List Price	UPC 695783	Part Number	List Price	UPC 695783
4	50922	P.O.A.	509224	48422	P.O.A.	484224
6	50923	212.22	509231	48423	212.22	484231
8	50924	256.06	509248	48424	256.06	484248
10	50925	390.77	509255	48425	411.48	484255
12	50926	494.83	509262	48426	521.07	484262

45° EII
Gasket x Gasket

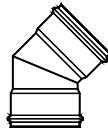

45° EII
Spigot x Gasket

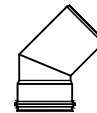

Size	DR 25			DR 18		
	Part Number	List Price	UPC 695783	Part Number	List Price	UPC 695783
4	50874	80.81	508746	48374	84.03	483746
6	50875	140.20	508753	48375	140.20	483753
8	50876	266.98	508760	48376	266.98	483760
10	50877	399.27	508777	48377	420.43	483777
12	50878	520.32	508784	48378	547.92	483784

Size	DR 25			DR 18		
	Part Number	List Price	UPC 695783	Part Number	List Price	UPC 695783
4	50946	P.O.A.	509460	48446	P.O.A.	484460
6	50947	212.22	509477	48447	212.22	484477
8	50948	256.06	509484	48448	256.06	484484
10	50949	390.77	509491	48449	411.48	484491
12	50950	494.83	509507	45450	521.07	484507

90° EII
Gasket x Gasket



90° EII
Spigot x Gasket

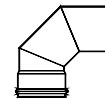

Size	DR 25			DR 18		
	Part Number	List Price	UPC 695783	Part Number	List Price	UPC 695783
4	50898	80.81	508982	48398	80.81	483982
6	50899	143.95	508999	48399	143.95	483999
8	50900	278.25	509002	48400	278.25	484002
10	50901	491.48	509019	48401	750.02	484019
12	50902	565.23	509026	48402	989.23	484026

Size	DR 25			DR 18		
	Part Number	List Price	UPC 695783	Part Number	List Price	UPC 695783
4	50970	P.O.A.	509705	48470	P.O.A.	484705
6	50971	292.66	509712	48471	292.66	484712
8	50972	320.22	509729	48472	337.05	484729
10	50973	488.61	509736	48473	514.34	484736
12	50974	599.10	509743	48474	630.63	484743

EIIs can be made to any angle. Contact factory for pricing.

DR 14 fittings available on request. Contact factory for pricing.

Tee
Gasket x Gasket x Gasket

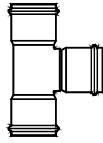

Size	DR 25			DR 18		
	Part Number	List Price	UPC 695783	Part Number	List Price	UPC 695783
4x4	51404	111.32	514044	48904	111.32	480943
6x4	51407	249.03	514075	48907	249.03	489076
6x6	51408	242.32	514082	48908	242.32	489083
8x4	51411	420.56	514112	48911	420.56	489113
8x6	51412	430.76	514129	48912	430.76	489120
8x8	51413	440.53	514136	48913	440.53	489137
10x4	51416	1354.11	514167	48916	1489.62	489168
10x6	51417	1373.46	514174	48917	1510.93	489175
10x8	51418	1392.82	514181	48918	1532.23	489182
10x10	51419	1412.14	514198	48919	1763.38	489199
12x4	51422	1431.47	514228	48922	1574.79	489229
12x6	51423	1450.79	514235	48923	1596.04	489236
12x8	51424	1470.15	514242	48924	1617.33	489243
12x10	51425	1489.48	514259	48925	1638.61	489250
12x12	51426	1508.85	514266	48926	1659.91	489267

Notes

DR 14 fittings available on request. Contact factory for pricing.

TERMS

Two percent discount for cash if paid not later than 10 days following date of invoice. Purchaser should inquire about the trade and cash discount in effect at any particular time.

Purchaser agrees to pay a finance charge of 1½ percent per month (18 percent annual rate) on all past due accounts. If purchaser's account is past due and is placed with an attorney for collection or suit, the purchaser agrees to pay attorney and court fees. All orders placed by accounts with a past due balance will be placed on credit hold until the account is brought current or other arrangements are made.

FREIGHT

All C-900/905 goods are sold F.O.B. point of shipment with full freight allowed to all shipping points within the United States except Alaska and Hawaii on net order value of \$1,500.00 or more.

Seller shall not be liable for failure to deliver or delays in delivery due to causes beyond Seller's control or the control of its suppliers and carriers.

MINIMUM ORDER

Orders must be at least \$100.00 net to be accepted.

CANCELLATION

Nonstandard or specially produced fittings cannot be cancelled once production has begun. Large quantities of a single product may require a non-cancelable agreement.

RETURNED GOODS

Goods will not be accepted for return without a Return Goods Authorization issued by Macon Plastics, Inc. A restocking charge and freight costs of returned goods (plus out freight if applicable) will be assessed. Special fittings or unreasonably large quantities are non-returnable. Fittings must be clean and in resalable condition.

LIMITED WARRANTY

Since the use of this product is beyond the control of the seller, liability of the seller shall be limited to replacement of product.

Macon Plastics, Inc. warrants that its products are manufactured free of defects in material and workmanship for a period of one year from date of purchase.

The limit of liability for failure of any of the products to meet foregoing warranties or breach of any warranty, express, implied or statutory shall be to supply an equivalent amount of product or refund of purchase price for any products returned to it within thirty (30) days of failure and found by Macon Plastics, Inc. to be defective.

This warranty does not apply to a product that has been subjected to; (a) improper storage or installation other than in accordance with ASTM D2321; (b) accident, damage, abuse or misuse; (c) abnormal or unusual operating conditions or applications; (d) operating conditions or applications above the rated capacity for the product; (e) operating conditions or applications not made known to Macon Plastics, Inc. prior to the date of the sale of the product; or (f) a purpose of application in any way different from that for which the product was designed.

Due to the widely varying conditions under which these products are used or installed, if these products are not installed within current industry standards, Macon Plastics, Inc. offers no warranty as to the length of service or suitability for any particular purpose of the products. In no event shall Macon Plastics, Inc. be liable for incidental or consequential damages.

Any action for breach of warranty must be brought within twelve (12) months from the date of delivery. Macon Plastics, Inc. retains the right to make changes or improvements from time to time in their products.

DISCLAIMER OF OTHER WARRANTIES

The warranty provided above is strictly limited to its terms and is in lieu of all other warranties, express, implied and statutory. Macon Plastics, Inc. specifically disclaims any implied warranties of merchantability or fitness for particular purpose.

Purchaser specifically understands and agrees that Macon Plastics, Inc., its successors, assigns, directors, officers, agents and employees shall not be liable in tort, whether based on negligence, strict liability, or any other theory of tort liability, for any action or failure to act in respect to the manufacture, preparation for sale, delivery, or use of Macon Plastics, Inc.'s products. It is the parties' intent to absolve and protect Macon Plastics, Inc. and Macon Plastics, Inc.'s successors, assigns, directors, officers, agents and employees from any and all tort liability.

Purchaser expressly agrees that its sole and exclusive remedy for breach of warranty set forth above, for any tort related conduct, or for any other cause of action, shall be the remedies set forth above.

Purchaser further specifically understands and agrees that, except provided, no remedy shall be available to purchaser, including, but not limited to claims for incidental, consequential, special or punitive damages, for any cause whatsoever, or injury to or death of persons or damage to property or any other consequential economic or incidental loss.

Under no circumstances will Macon Plastics, Inc. be liable for loss of anticipated profits or any other loss caused by reason of the non-operation of, or the increased expense of operation caused by Macon Plastics, Inc.'s products. This exclusion shall apply to all claims, whether sounding in tort, contract or otherwise and shall apply to all damages.

CLAIMS FOR SHORTAGE OR DAMAGE

Shortage claims must be made within ten (10) days from receipt of goods.

Claims for lost shipments, goods damaged in transit, or error in shipment must be made by consignee with the delivering carrier.

NOTICE

Possession of this price list is not an offer to sell. All orders are subject to acceptance by Macon Plastics, Inc. Prices shown on this price sheet supersede all previous issues, and are subject to change without notice.

Orders shall not be binding until approved at Seller's office in Macon, Georgia.

This agreement shall be governed in accordance with the laws of the State of Georgia, therefore all litigation will take place in the State of Georgia.